



DESIGN[ED] FOR YOU

2022 [COLLECTION]

# daao

DAAO – Design and Architecture Atelier presents our Furniture Collection developed by DAAO Studio.

Being developed in the last two years, this Collection brings to the domestic furniture a new concept. Of functional aspect, DAAO Collection prioritizes its use and the purpose for which it is intended, dispensing devices or purely decorative forms.

It is our belief that the function generates the form and that the intent of the design stands out from the artifice of the same.



## CONTACTS

email:  
[info@daao.pt](mailto:info@daao.pt)

web page:  
[www.daao.pt](http://www.daao.pt)

phone:  
+351916281898

instagram  
#daaoconcepts

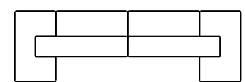
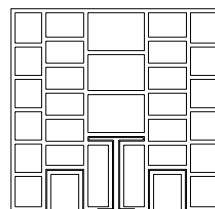
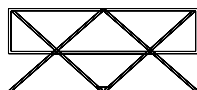
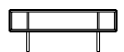
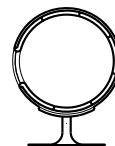
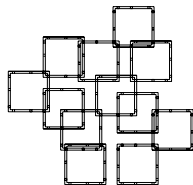
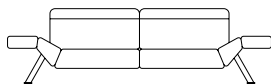

design:  
daao graphics  
photography  
bruno veiga  
daao studio

[info@daao.pt](mailto:info@daao.pt) [www.daao.pt](http://www.daao.pt)

In this Collection the design was a reciprocal game between the object and the space involved, to which is normally intended the habitat.

The environment and its disposal in space thus become a priority, as we begin to create the concept.

THE MODERN LIFE  
REQUIRES ADAPTABILITY  
AND FLEXIBILITY.  
ALL OF OUR PRODUCTS  
HAVE ONE THING IN  
COMMON:  
FUNCIONAL AND  
AESTHETIC QUALITY

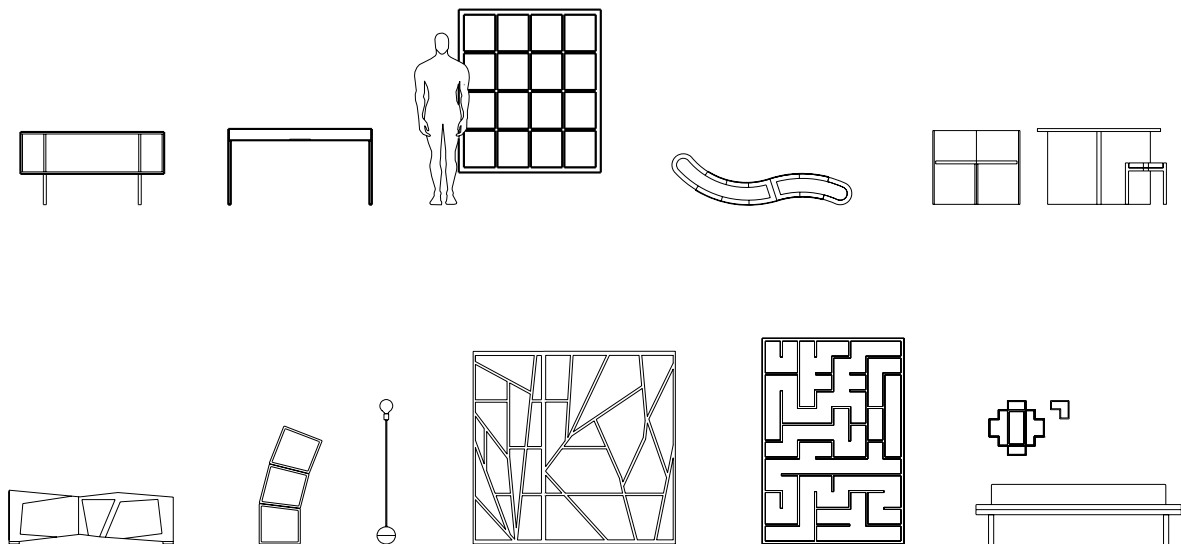

THIS BROCHURE OFFERS A OVERVIEW OF OUR COLLECTION. **WELCOME TO DAAO** COLLECTION

[info@daao.pt](mailto:info@daao.pt) [www.daao.pt](http://www.daao.pt)

## DESIGN[ED] FOR YOU

We intend to bring to the furniture a new concept, being functional, fun, and useful, based on versatility, minimalism and modularity.

I



## (RE)THINK THE MODULAR

N

Structures can be assembled and disassembled. Our structures, shelves and modular solutions is perfectly adaptable to the changing needs that current families have and the different spaces that people come to inhabit during their lifetime.



S

Some of our furniture proposal fits in a DIY trend. In modular solution using more or less modules, each user can very simply build himself/herself a unique piece of furniture. This philosophy is applicable in our furniture pieces.

P



I

R

The structures are adaptable to the changing needs of families or businesses, creating different spaces that people come to inhabit during their life, and growing as needed. Our products name's is numbers, discovery our collection.

E



## RELAX[ING]

To project, plan and formulate is thus not a linear process, standing out by the interlacing of the design with a concept and these with multiple materials. The ultimate result is a highly usable pieces of furniture.

Y O

Thus, a project must be useful, comfortable in its use and serious... after these assumptions, the object becomes beautiful, which allows us, perhaps, to speak in the poetic and intrinsic quality of the objects that surround us.

S E



The environment and its disposal in space thus become a priority, as we begin to create and design a new concept. All this provision communicates to the viewer, creating a bond with him. This is the design.

## [RE]IMAGINE



An object, to us, is not just a project. It born from a concept absorbed by the surrounding culture, it grows and it is returned to this culture, now with a shape and able to be used. Simple clever and inventive.

U R

In this Collection the design was a reciprocal game between the object and the space involved, to which is normally intended the habitat. Our concept collection are developed in this diligent design process.



L

F





# SIDEBOARD 12

DESIGN: DANILO OLIM 2019

**SIDEBORD 12**  
**DESIGN[ED]**  
**FOR YOU**

W1400 x D420 x H680  
Design: Danilo Olim 2019  
by DAAO





**Sideboard 12** is inspired by the structure of a bridge. Defies beauty by assuming an elegant, structural design. We think that good design should take shape, last in time, overcome trends and make your life easier and more beautiful.



## SIDEBOARD 12 and 12.1

### INSPIRE YOURSELF

technical information

**Birch wood**

DESIGN: Danilo Olim by DAAO

2019

### SIDEBOARD 12



W 1400 x D 420 x H 680mm

### SIDEBOARD 12.1

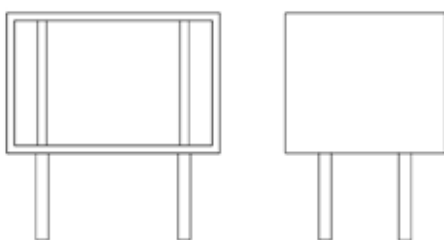

W 600 x D 420 x H 680mm



OAK



WALNUT



BIRCH

#### SHIPPING

Contact us to find the best shipping method for you.

#### BOX SIDEBOARD

##### 12 SIZE:

Width 1500 x Depth 480  
x Height 750mm

#### BOX SIDEBOARD

##### 12.1 SIZE:

Width 700 x Depth 480 x  
Height 750mm

**MATERIALS.** Come with us and have a look at our materials.

**FABRICS.** The fabrics shown here, are but only a selection of colours from the collection. We are always searching for high-quality furniture fabrics from renowned manufacturers.

**LEATHER.** Our collection offers different types of leather, with different thickness, colour and pattern.

**FINISHING.** You can choose from wood or lacquer.

Check Available woods and colours.

#### DAAO guarantee

The guarantee of our furniture covers material and manufacturing imperfections, namely the structure, covering, ironware, textiles and the finishing, as from the date of purchase and during a period of 2 years.



# SIDEBOARD 07

DESIGN: DANILO OLIM 2020

**DESIGN[ED] FOR YOU  
SIDEBOARD 07**

W1600 x D430 x H700

Design: Danilo Olim 2020  
by DAAO





The **07 Sideboard** is a solution for work and home environments. The closed / open doors with tilting hardware highlight the beauty of the door. The joints when rotating on an axis emphasize the opening movement. The **07** is available in different wood options (see technical page).



## SIDEBOARD 07 INSPIRE YOURSELF

technical information.  
DESIGN: Danilo Olim by  
DAAO 2019

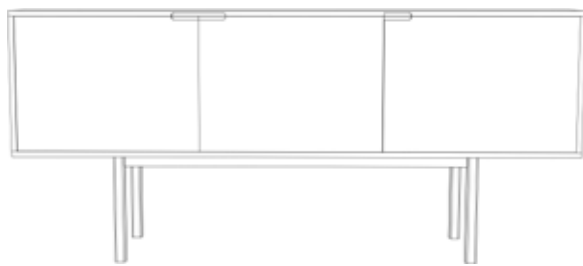

SIDEBOARD 07 FRONT VIEW

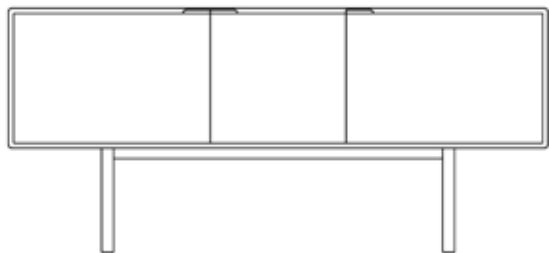

W 1600x D 420 x H 700mm

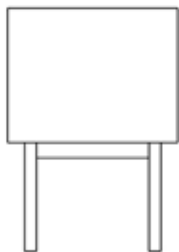

SIDEBOARD 07 RIGHT / LEFT VIEW



OAK



WALNUT



BIRCH

### SHIPPING

Contact us to find the best shipping method for you.

**BOX SIDEBOARD 07 SIZE:**  
Width 1800 x Depth 480  
x Height 750mm

**MATERIALS.** Come with us and have a look at our materials.

**FABRICS.** The fabrics shown here, are but only a selection of colours from the collection. We are always searching for high-quality furniture fabrics from renowned manufacturers.

**LEATHER.** Our collection offers different types of leather, with different thickness, colour and pattern.

**FINISHING.** You can choose from wood or lacquer. Check Available woods and colours.

### DAAO guarantee

The guarantee of our furniture covers material and manufacturing imperfections, namely the structure, covering, ironware, textiles and the finishing, as from the date of purchase and during a period of 2 years.



TABLE / DESK 13  
DESIGN: DANILO OLIM 2019



DESIGN[ED] FOR YOU  
**TABLE / DESK 13**  
Solid Oak wood  
W140xD90xH77  
Design: Danilo Olim by DAAO 2019



**TABLE / DESK 13**  
+ Information see technical sheet









The desk offers two electricity points as well as two spaces for papers. Use as best suits you or adapt to the time of day opening and closing at the right times.

**Table 13** can be made in oak, walnut or birch.



The modern life requires flexibility and adaptability. This table adapted to your changing needs.

**Table 13** is a table or a desk.

You can open and work, close and use table with your family



**Table 13** can be used in its natural design as a table with capacity for 6 people. However, it hides inside a desk that opens and closes through the opening of the table top, in an easy and light movement.

**TABLE / DESK 13**  
**DESIGN[ED] FOR**  
**YOU**

technical information  
 DESIGN: Danilo Olim by  
 DAAO 2019



**TABLE 13 SIZE:**  
 Width 1400 x Depth 900  
 x Height 780mm

**DAAO guarantee**

The guarantee of our furniture covers material and manufacturing imperfections, namely the structure, covering, ironware, textiles and the finishing, as from the date of purchase and during a period of 2 years.

-  OAK
-  WALNUT
-  BIRCH

**SHIPPING**

Contact us to find the best shipping method for you.

**FREIGHT BOX TABLE 13**

SIZE:  
 W 1550mm x D 1000mm  
 H 850mm

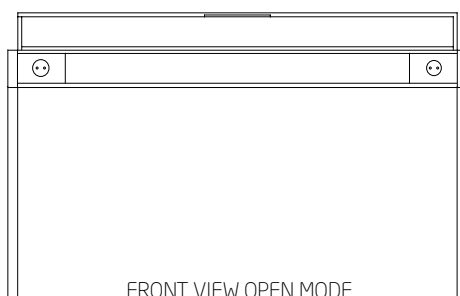
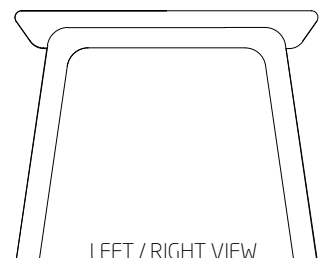
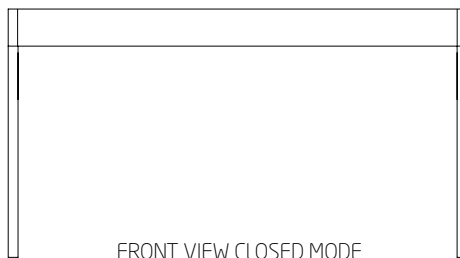
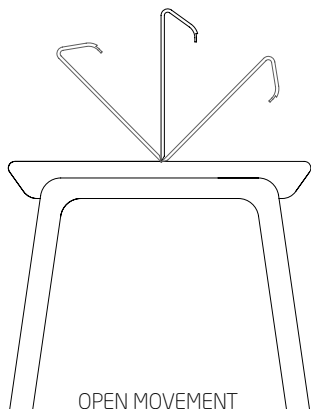

**MATERIALS**

Come with us and have a look at our materials.

**FINISHING.**

You can choose from wood or lacquer. Check with us available woods and colours.



TABLE 23  
DESIGN: DANILO OLIM 2017



**TABLE 23**  
**DESIGN[ED] FOR**  
**YOU**

DESIGN: Danilo Olim by  
 DAAO 2017

Tidy, open for 4, 6 or 8  
 people



OAK



WALNUT



BIRCH

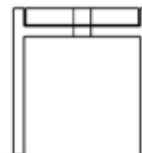
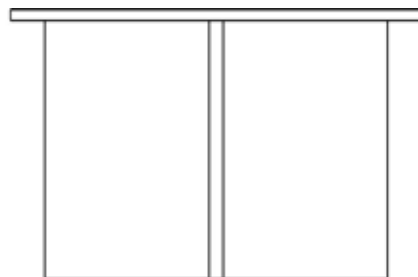
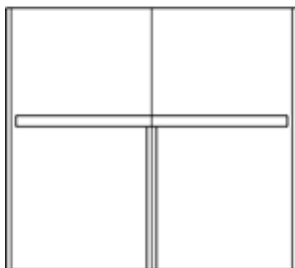

**MATERIALS**

Come with us and have a  
 look at our materials.

**FINISHING.**

You can choose from  
 wood or lacquer.  
 Check with us available  
 woods and colours.

TABLE 23 SIZE:  
 Width 1000 x Depth 100  
 x Height 740mm

**DAAO guarantee**

The guarantee of our fur-  
 niture covers material and  
 manufacturing imperfec-  
 tions, namely the structure,  
 covering, ironware, textiles  
 and the finishing, as from  
 the date of purchase and  
 during a period of 2 years.

**SHIPPING**

Contact us to find the  
 best shipping method for  
 you.

**FREIGHT BOX TABLE 23**

SIZE:  
 W 1200mm x D 1200mm  
 H 850mm



COFFEE TABLE 12.2  
DESIGN: DANILO OLIM 2020

## DESIGN[ED] FOR YOU

### COFFEE TABLE 12.2

Solid Chest nut wood

W40xD80xH73

Design: Danilo Olim 2020

by DAAO



This model is made in solid Chest nut wood.

The coffee table **12.2** is a combination of handcraft experts and digital tools. This table series (12.2, 12.3 and 12) is a fun and daring combination of shapes in natural wood.



The modern life requires flexibility and adaptability. This table adapted to your changing needs. **12.2** is a coffee table with two sizes, see + Information in technical sheet



DESIGN[ED] FOR  
YOU  
COFFEE TABLE 12.2  
/ 12.3

technical information  
Solid Chest nut wood  
DESIGN: Danilo Olim by  
DAAO 2020

TABLE 12.3

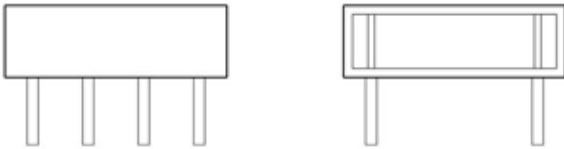

W 600x D 500 x H 400mm

TABLE 12.2

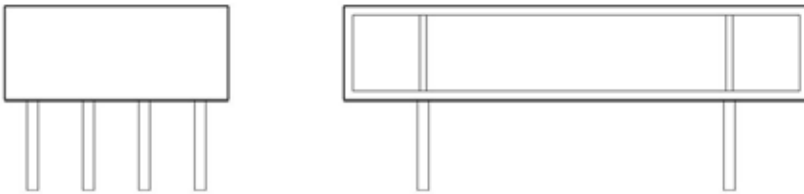

W 1000 x D 500 x H 400mm



**SHIPPING**

Contact us to find the best shipping method for you.

**BOX TABLE 12.2 SIZE:**  
Width 1050 x Depth 550  
x Height 500mm

**BOX TABLE 12.3 SIZE:**  
Width 650 x Depth 550 x  
Height 500mm

**MATERIALS.** Come with us and have a look at our materials.

**FABRICS.** The fabrics shown here, are but only a selection of colours from the collection. We are always searching for high-quality furniture fabrics from renowned manufacturers.

**LEATHER.** Our collection offers different types of leather, with different thickness, colour and pattern.

**FINISHING.** You can choose from wood or lacquer. Check Available woods and colours.

**DAAO guarantee**

The guarantee of our furniture covers material and manufacturing imperfections, namely the structure, covering, ironware, textiles and the finishing, as from the date of purchase and during a period of 2 years.



# SHELVES 17

RE DESIGN: DANILO OLIM 2017

SYSTEM 17 IS AN ORIGINAL PRODUCT BY DAAO



**Shelves 17** has a thickness of 70mm and may have any height or width desired. Made up by multiple shelves, this bookcase can be designed in all sorts of different sizes, with no limitations in dimensions.



## DESIGN[ED] FOR YOU SHELVES 17

Redesign: Danilo Olim by  
DAAO 2017

Available wood are: Wal-  
nut, Birch plywood or Oak.  
1 shelf (measures in millim-  
eters): W 300 x H 340



Board with shelves with  
an independent organiza-  
tion. Opens one, two, or  
all, adapting to the most  
suitable organization.  
**Bookshelf 17** was de-  
veloped with the premise  
to occupy the necessary  
space, when necessary.

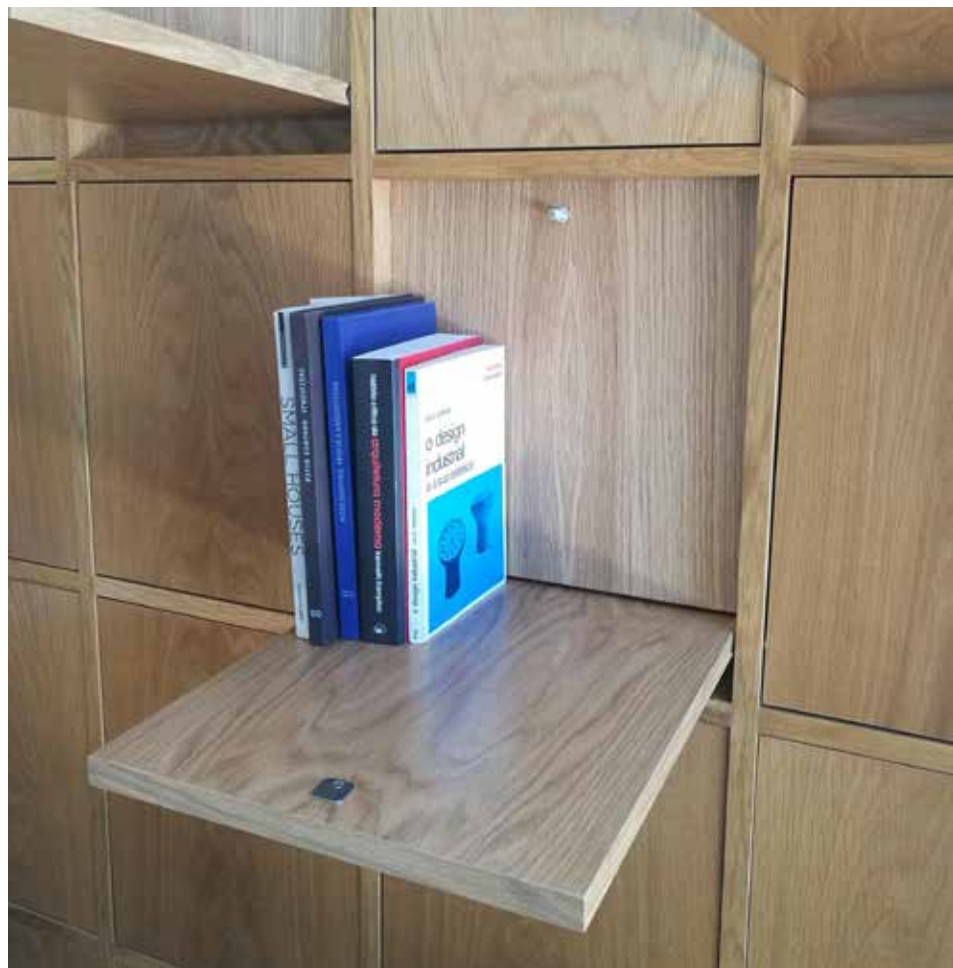

Considered to be an exten-  
sion of the wall when all  
shelves are closed, or when  
not being used, and open-  
ing the shelves as needed.  
They open by pressing the  
shelf slightly inward with  
one click on the magnetic  
bracket



ASSEMBLY  
INSTRUCTIONS  
17 - SHELVES SYSTEM

CONTENT

BEAM VARIABLE  
A x 1Panel Shelves

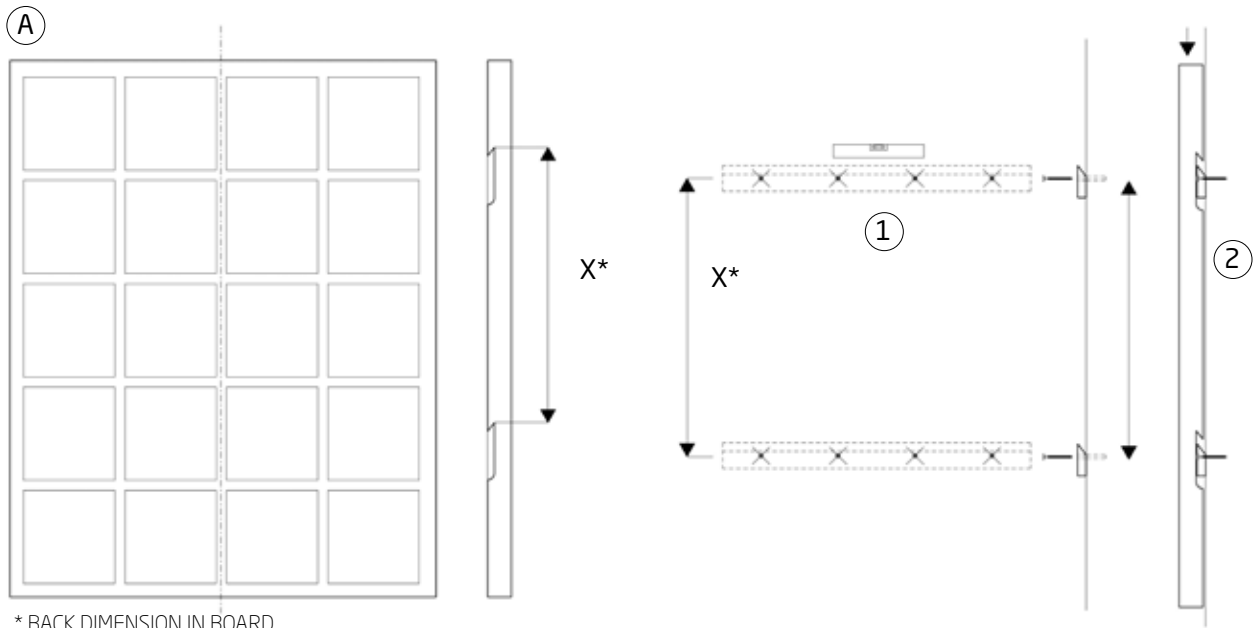

\* BACK DIMENSION IN BOARD



1 - MARK FOUR POINTS, CHECK THE DISTANCE BETWEEN HOLES IN RAWPLUGS. DRILL FOUR HOLES WITH 7MM

2 - PLACE THE PANEL IN RAWPLUGS

(B) B x 2 RAWPLUGS

(C) C x 8 SCREWS





**SHELVES 17**

Birch, Walnut or Oak wood

**SIZE 3**, 1x4 shelves

**W**400 x **D**70 x **H** 1615mm



**SHELVES 17**

Birch, Walnut or Oak wood

**SIZE 2**, 2x4 shelves

**W**735 x **D**70 x **H** 1615mm



**Shelves 17 System**

**1x2**

Modulo 1x2 shelves

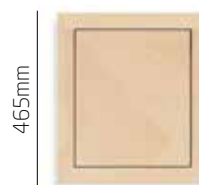

**Shelves 17 System**

**1x1**

Modulo 1x1 shelves

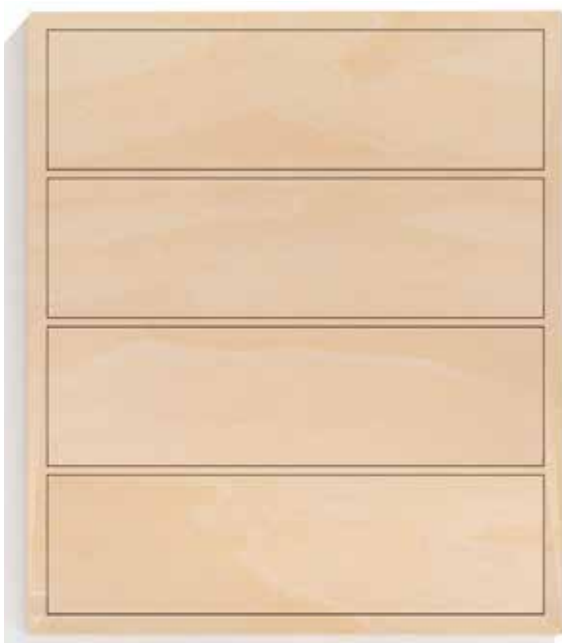

**Shelves 17 System LONGUE**

**SHELVE**

Birch, Walnut or Oak wood

**SIZE 3**, 1x4 shelves

**W**1385 x **D**70 x **H**1615mm

1615mm



**SHELVES 17**

Birch or Oak wood

**SIZE 1**, 4x4 shelves

**W**1385 x **D**70 x **H**1615mm

Size 1 4x4

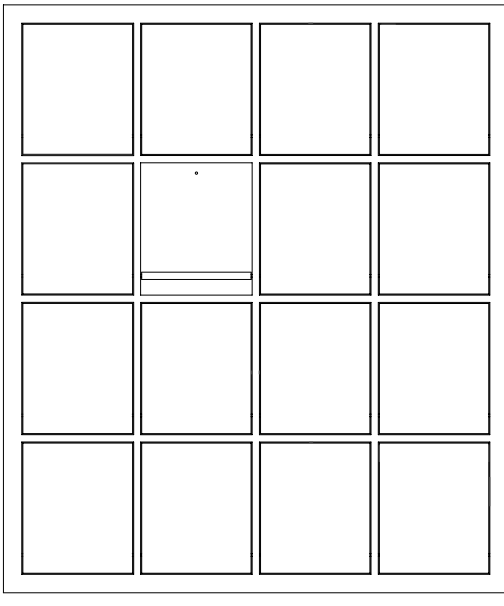

1385

Size 2 2x4

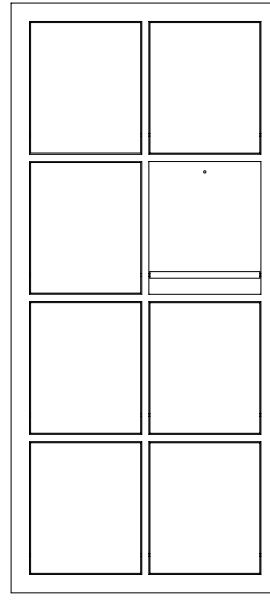

735

Size 3 1x4

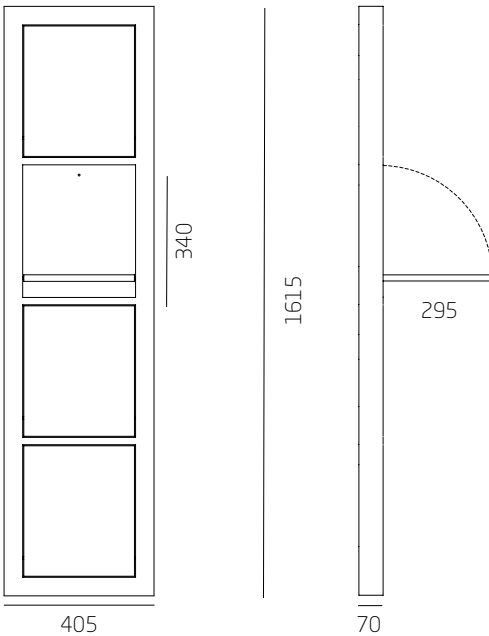

340

1615

295

405

70

Size 4 1x2

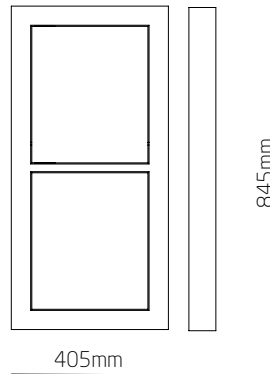

845mm

405mm

Size 5 1x1

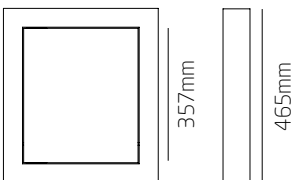

357mm

465mm

### 5 Standart sizes.

This bookcase can be designed in all sorts of different sizes, with no limitations in dimensions.

**Shelves 17** has a thickness of 70mm and may have any height or width desired. The shelves are extremely robust capable of witholding a shelf full of books.

## SHELVES 17

technical information  
REDESIGN: Danilo Olim  
by DAAO 2017  
Original design: 2012  
Danilo Olim Collection



OAK



WALNUT



BIRCH

### SHIPPING

Contact us to find the best shipping method for you.

### FREIGHT BOX 17 SIZE:

Example to size 3.  
Width 0.8m, Depth 0.12m,  
Height 1.80m

**MATERIALS.** Come with us and have a look at our materials.

**FINISHING.** You can choose from wood or lacquer. Check Available woods and colours.

### DAAO guarantee

The guarantee of our furniture covers material and manufacturing imperfections, namely the structure, covering, ironware, textiles and the finishing, as from the date of purchase and during a period of 2 years.





# ARMCHAIR 88

DESIGN: DANILO OLIM 2020



**RELAX[ING]**  
**ARMCHAIR 88**

Design: Danilo Olim by  
DAAO 2020

**88** explores the possibilities of a dynamic and fun sitting.

**88** is available in a range of colours.





**88 Armchair** is an unconventional chair for relaxing. The structure of 88 Chair consists of a slim wood rounded profile with appealing textile. **88** offers an entirely new sitting experience marked by a comfortable range of positions.



800 x 1000 x 1400mm

## ARMCHAIR 88 RELAX[ING]

technical information  
DESIGN: Danilo Olim by  
DAAO 2020

LEATHER AVAILABLE  
COLOURS

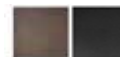

FABRICS AVAILABLE  
COLOURS



Our collection offers different types of **leather** and **fabrics**. Come with us and have a look at our materials.



OAK



WALNUT



BIRCH

### SHIPPING

Contact us to find the best shipping method for you.

### BOX SIZE:

Box with: Width 1.2m,  
Depth: 1m, Height 1.5 m,

**MATERIALS.** Come with us and have a look at our materials.

**FABRICS.** The fabrics shown here, are but only a selection of colours from the collection. We are always searching for high-quality furniture fabrics from renowned manufacturers.

**LEATHER.** Our collection offers different types of leather, with different thickness, colour and pattern.

**FINISHING.** You can choose from wood or lacquer. Check Available woods and colours.

# daao

Being developed in the last two years, this Collection brings to the domestic furniture a new concept. Of functional aspect, DAAO Collection prioritizes its use and the purpose for which it is intended, dispensing devices or purely decorative forms.

It is our belief that the function generates the form and that the intent of the design stands out from the artifice of the same. In this Collection the design was a reciprocal game between the object and the space involved, to which is normally intended the habitat.

The environment and its disposal in space thus become a priority, as we begin to create the concept.

## d STUDIO

email:  
[info@daao.pt](mailto:info@daao.pt)

web page:  
[www.daao.pt](http://www.daao.pt)

phone:  
**+351916281898**

instagram  
**#daaoconcepts**

design:  
**daao graphics**

photography  
**Bruno Veiga**  
**daao studio**

### DAAO guarantee

The guarantee of our furniture covers material and manufacturing imperfections, namely the structure, covering, ironware, textiles and the finishing, as from the date of purchase and during a period of 2 years.



CHAISE LONGUE 21  
DESIGN: DANILO OLIM 2019

RELAX[ING]  
CHAISE LONGUE 21

Chest nut wood

Backrest: black leather

W1.80xD 0.55xH0.26m

Redesign: Danilo Olim by  
DAAO 2019

+ Information  
see technical sheet



Position 1



Position 2

Removable backrest  
Foam-backed or woven  
foam back.







The 21 is a Chaise longue or a rocking chair. The 21 is composed by 2 modules that rotate 360 degrees between them. Try it and whirl it again. The chaise longue 21 is very comfortable and fun in the two positions.







# RELAX[ING] CHAISE LONGUE 21

Technical information  
W1.80xD 0.55xH 0.26m  
Re design: Danilo Olim  
by DAAO 2019

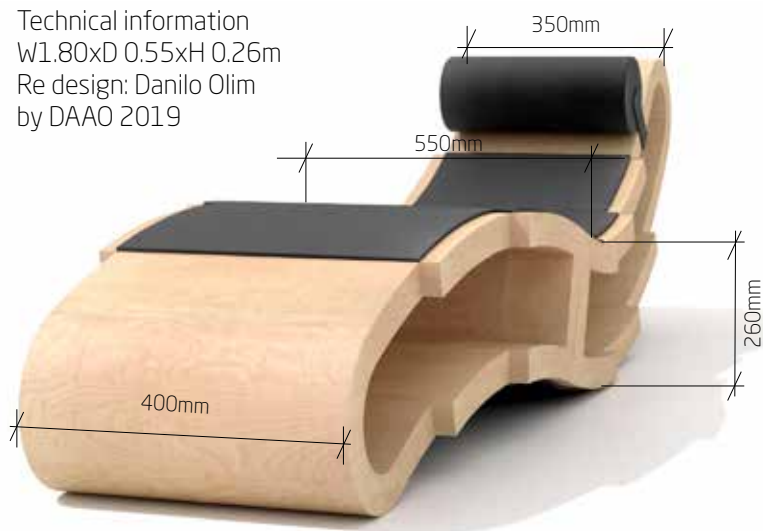

### Removable backrest

Available in Black leather, Brown Leather and Fabrics (Available in various colours)

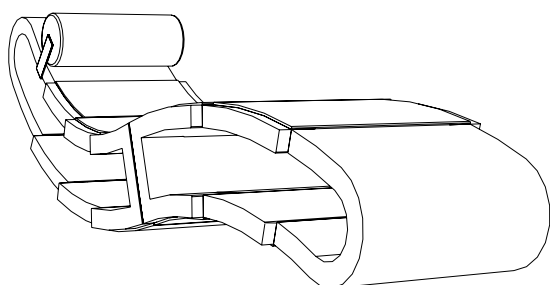

POSITION 1: CHAISE LONGUE

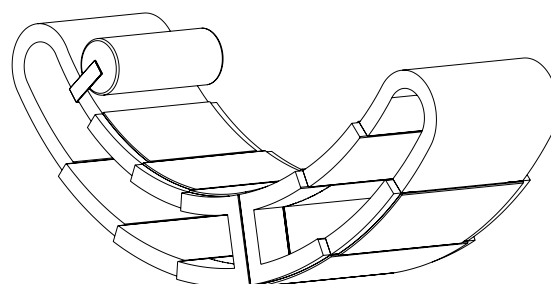

POSITION 2: ROCKING CHAIR

**MATERIALS.** Come with us and have a look at our materials.

**FABRICS.** The fabrics shown here, are but only a selection of colours from the collection. We are always searching for high-quality furniture fabrics from renowned manufacturers.

**LEATHER.** Our collection offers different types of leather, with different thickness, colour and pattern.

**FINISHING.** You can choose from wood or lacquer. Check Available woods and colours.



OAK



WALNUT



BIRCH

### DAAO guarantee

The guarantee of our furniture covers material and manufacturing imperfections, namely the structure, covering, ironware, textiles and the finishing, as from the date of purchase and during a period of 2 years.

### SHIPPING

Contact us to find the best shipping method for you.

### FREIGHT BOX: 21 SIZE:

Width 2 m, Depth 0.6m, Height 0.4m



# MODULE 22

DESIGN: DANILO OLIM 2016

## MODULE 22 [RE]THINK THE MODULAR

Design: Danilo Olim by  
DAAO 2016

The 22 is a module with  
five fitting hypotheses  
+ Information  
see technical sheet



On one hand, our proposal fits in a DIY trend, in the sense that, using more or less modules, each user can easily build himself / herself a unique piece of furniture. On the other hand, the practicality and ease with which the structure can be assembled and disassembled.

That joins itself creating a bigger structure according to your needs. The structure is perfectly adaptable to the changing needs that current families have and the different spaces that people come to inhabit during their lifetime.





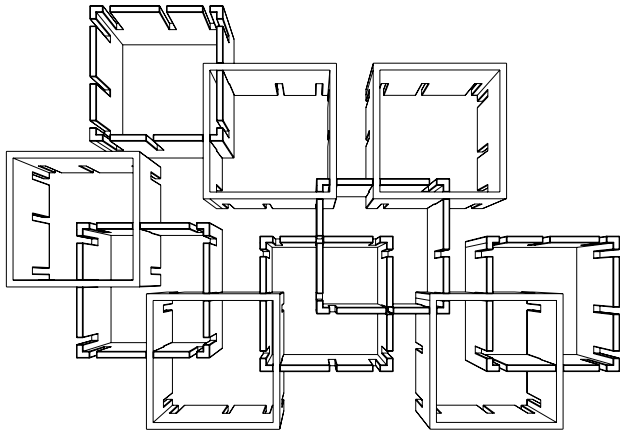

**MODULE 22**  
**[RE]THINK THE**  
**MODULAR**

technical information  
 REDESIGN: Danilo Olim by  
 DAAO 2016.

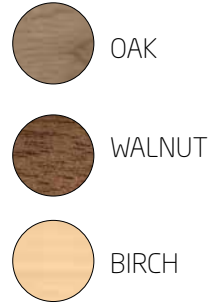

**MATERIALS.**

Come with us and have a look at our materials.

**FINISHING.**

You can choose from wood or lacquer. Check Available woods and colours.

Construct your modular bookshelve with **Module 22**, using five fitting hypotheses and your imagination

Module 22, **five fitting** hypotheses

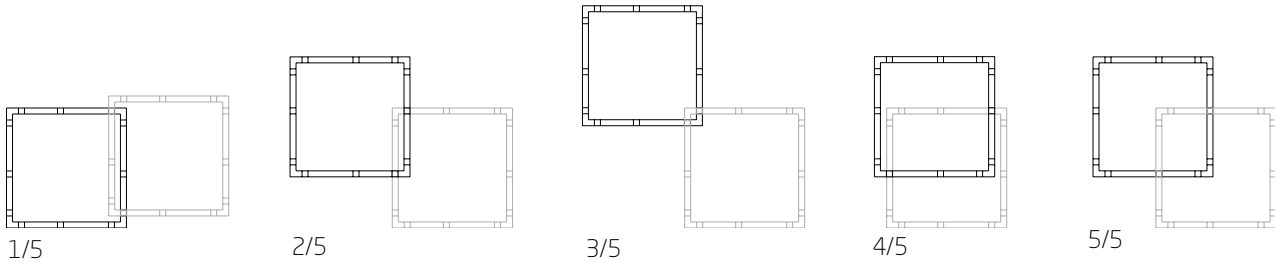

**FREIGHT BOX UNIT** - 1, 2 and 4 Modules

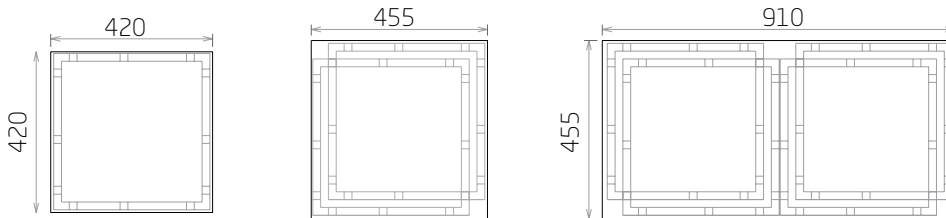

**SHIPPING**

Contact us to find the best shipping method for you.

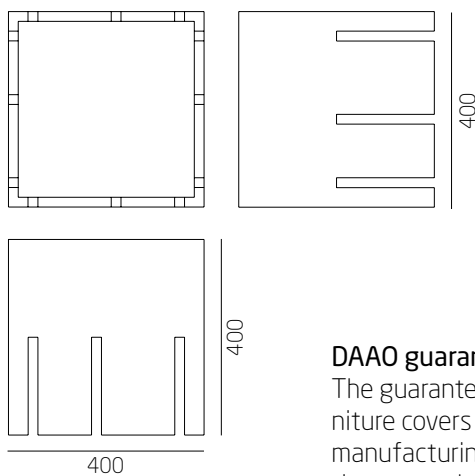

**DAAO guarantee**

The guarantee of our furniture covers material and manufacturing imperfections, namely the structure, covering, ironware, textiles and the finishing, as from the date of purchase and during a period of 2 years.

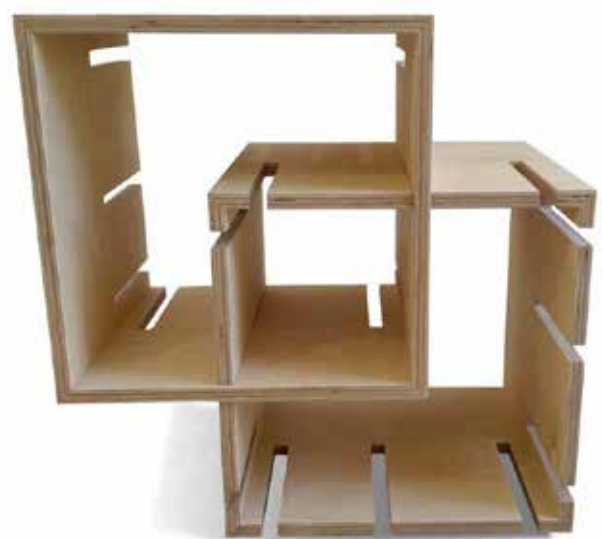



# MODULE 77

DESIGN: DANILO OLIM 2017

**MODULE 77**  
**[RE]THINK**  
**THE MODULAR**

Design: Danilo Olim by  
DAAO 2017

The 77 is a module that  
combines and multiplies  
itself for endless structure  
possibilities.



The act of constructing  
the piece, creates a deeper  
sense of ownership,  
promoting creativity and  
invention.

The pieces are inserted in  
each other, facing either  
forward or backwards.

The 77 is a small piece, that  
can go unnoticed when iso-  
lated, highly gains in terms  
of structural resistance  
and formal output, when  
grouped.

One storage and shelving  
module that combines and  
multiplies itself for endless  
structure possibilities.







The structure of 77 is perfectly adaptable to the changing needs that current families have and the different spaces that people come to inhabit during their lifetime. Any user can assemble, transform, create and recreate an endless number of shapes and sizes



BACK FACING NOTCHES



FRONT FACING NOTCHES

## MODULE 77

technical information  
DESIGN: Danilo Olim by  
DAAO 2017



OAK



WALNUT



BIRCH

### THE CONCEPT

A structural efficiency is attained with this piece, sprung from a familiar natural pattern. This hexagonal pattern is constituted by grouping the same shape over a plane, potentially filling the entire surface, without intervals

### ASSEMBLY PROCESS

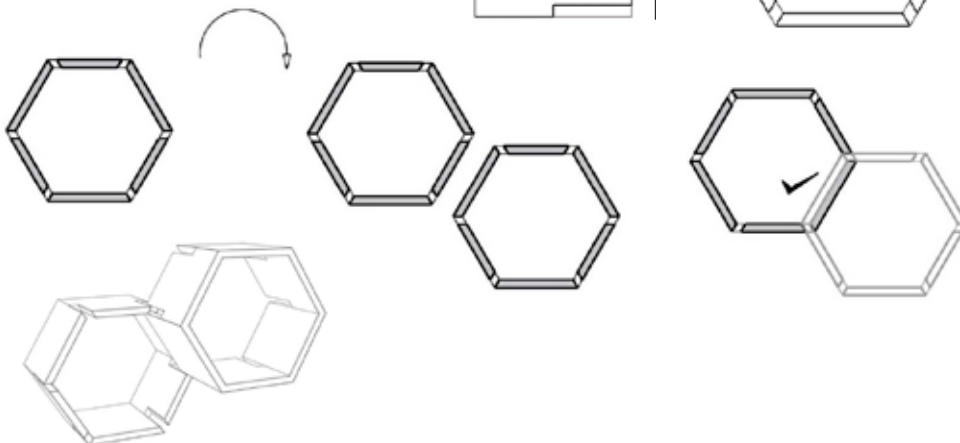

Module 77 is extremely easy assembly process

### SHIPPING

Contact us to find the best shipping method for you.

### BOX MODULE 77 SIZE:

Box with two modules.  
Width 0.7m, Depth 0.3m,  
Height 0.45m

**MATERIALS.** Come with us and have a look at our materials.

**FABRICS.** The fabrics shown here, are but only a selection of colours from the collection. We are always searching for high-quality furniture fabrics from renowned manufacturers.

**LEATHER.** Our collection offers different types of leather, with different thickness, colour and pattern.

**FINISHING.** You can choose from wood or lacquer. Check Available woods and colours.

### DAAO guarantee

The guarantee of our furniture covers material and manufacturing imperfections, namely the structure, covering, ironware, textiles and the finishing, as from the date of purchase and during a period of 2 years.

### MODULES 77

The most valuable feature of this piece is the locking system that allows to construct a bookcase or shelf without using any type of bolt, screw or gluing. This simplicity makes for an extremely easy assembly process.

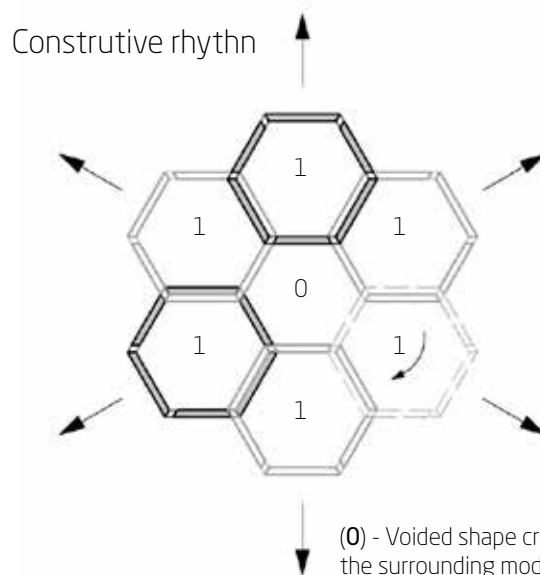

The modular scheme is infinite

(0) - Voided shape created by the surrounding modules  
(1) - Possible position for the module (path of structural development)



# BOOKSHELVE 25

DESIGN: DANILO OLIM 2016

## BOOKSHELVE 25 INSPIRE YOURSELF

Design: Danilo Olim by  
DAAO 2016

A piece of furniture full  
of books, a table and two  
benches.

Because there's nothing  
better in a library than a  
support for your books  
and a stool to sit.

We store books... benches  
and table.





Model with standard measurements, however you can adjust the space between shelves it to any other.  
This piece is divided in 3 modules, left/right module and center module.



## BOOKSHELVE 25 INSPIRE YOURSELF

technical information  
DESIGN: Danilo Olim by  
DAAO 2016



OAK



WALNUT



BIRCH

SHELVES 25 IS COMPOSITE PER 3 MODULES: LEFT / RIGHT AND MIDDLE MODULE.  
Model with standard measurements, however you can adjust it to any other Shelves 25.

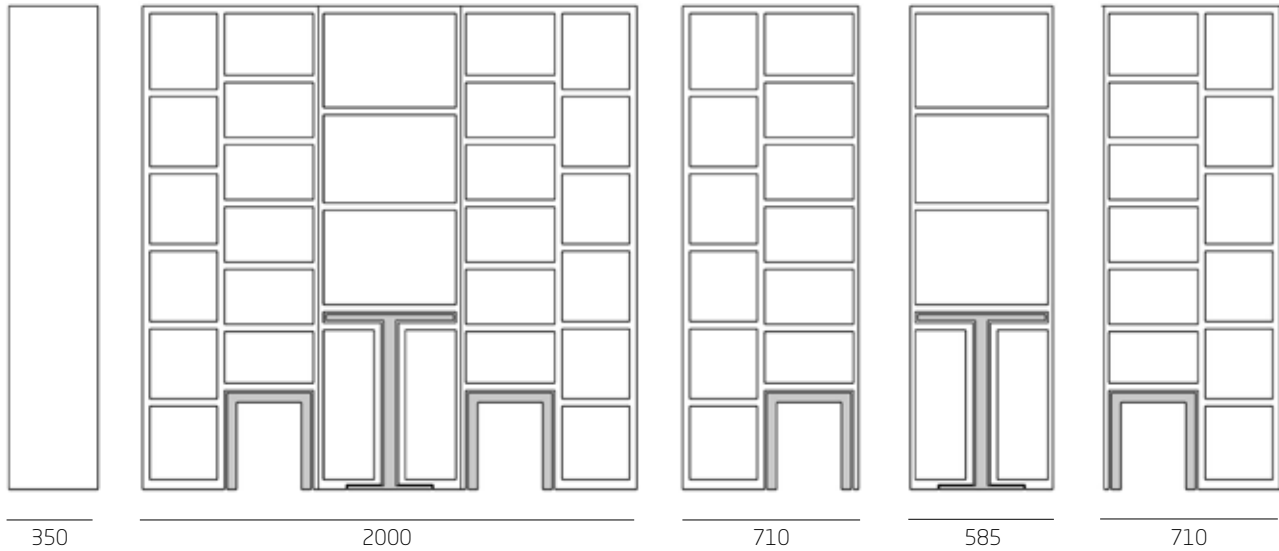

Height 2050mm

(MEASURES IN MILIMETERS)

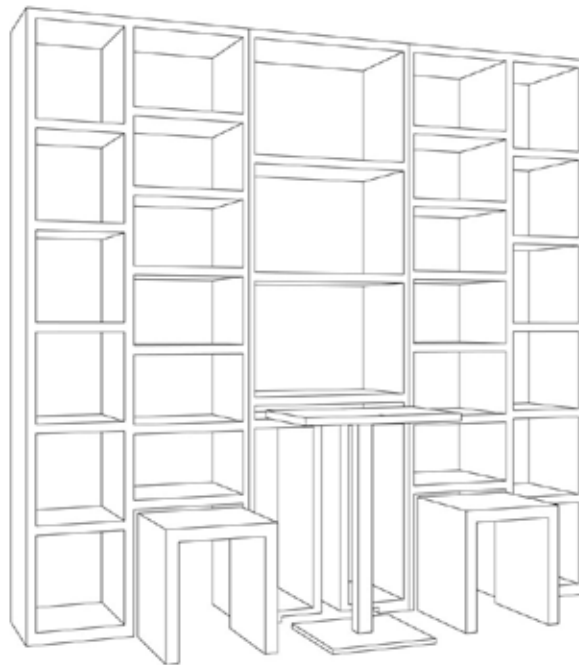

**MATERIALS.** Come with us and have a look at our materials.

**FABRICS.** The fabrics shown here, are but only a selection of colours from the collection. We are always searching for high-quality furniture fabrics from renowned manufacturers.

**LEATHER.** Our collection offers different types of leather, with different thickness, colour and pattern.

**FINISHING.** You can choose from wood or lacquer. Check Available woods and colours.

### SHIPPING

Contact us to find the best shipping method for you.

### BOXES SIZE:

Two boxes with: Width 0.74m, Depth 0.37m, Height 2.1 m, One box with: Width 0.6m, Depth 0.37m, Height 2.1 m

### DAAO guarantee

The guarantee of our furniture covers material and manufacturing imperfections, namely the structure, covering, ironware, textiles and the finishing, as from the date of purchase and during a period of 2 years.



INSPIRE YOURSELF

MODULE 18  
DESIGN: DANILO OLIM 2016

## SHELVES 18 INSPIRE YOURSELF

Design: Danilo Olim by  
DAAO 2016

The 18 is composed by 3  
modules that rotate 360  
degrees between them.  
Mix up - try it and whirl it  
again.







## SHELVES 18

technical information  
DESIGN: Danilo Olim by  
DAAO 2016



800 x 1000 x 1400mm

# daao

Being developed in the last two years, this Collection brings to the domestic furniture a new concept. Of functional aspect, DAAO Collection prioritizes its use and the purpose for which it is intended, dispensing devices or purely decorative forms.

It is our belief that the function generates the form and that the intent of the design stands out from the artifice of the same. In this Collection the design was a reciprocal game between the object and the space involved, to which is normally intended the habitat.

The environment and its disposal in space thus become a priority, as we begin to create the concept.



STUDIO

email:  
[info@daao.pt](mailto:info@daao.pt)

web page:  
[www.daao.pt](http://www.daao.pt)

phone:  
**+351916281898**

instagram  
**#daaoconcepts**

design:  
**daao graphics**

photography  
**Bruno Veiga**  
**daao studio**

### DAAO guarantee

The guarantee of our furniture covers material and manufacturing imperfections, namely the structure, covering, ironware, textiles and the finishing, as from the date of purchase and during a period of 2 years.



OAK



WALNUT



BIRCH

**MATERIALS.** Come with us and have a look at our materials.

**FABRICS.** The fabrics shown here, are but only a selection of colours from the collection. We are always searching for high-quality furniture fabrics from renowned manufacturers.

**LEATHER.** Our collection offers different types of leather, with different thickness, colour and pattern.

**FINISHING.** You can choose from wood or lacquer. Check Available woods and colours.

### SHIPPING

Contact us to find the best shipping method for you.

### BOXE SIZE:

Box with: Width 0.4m,  
Depth 0.4m, Height 1.25 m



LAMP 14  
DESIGN: DANILO OLIM 2016

## LAMP 14 INSPIRE YOURSELF

Design: Danilo Olim by  
DAAO 2016

The 14 lamp is an audacious and amusing point of light with chrome or gold finishing.



This lamp maintains itself upright in spite of its ballshaped base. Lamp with metal and steel structure. Height 1300 mm, base (ball) 200mm, E27, 42W. The light can be detached from the bulb, so you don't have to throw out the entire light bulb.



## LAMP 14

technical information  
DESIGN: Danilo Olim by  
DAAO 2016

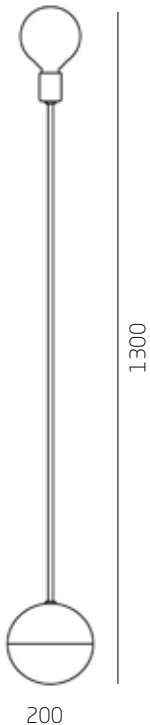

AVAILABLE LIGHT BULBS  
(Image by ZANGRA web site)  
ZANGRA.COM



**MATERIALS.** Come with us and have a look at our materials.

**METAL.** Our collection offers different types of METAL, with different thickness, colour and pattern.

**FINISHING.** You can choose from Chrome, Laquer (check vailable colours.) or Laton.

### DAAO guarantee

The guarantee of our furniture covers material and manufacturing imperfections, namely the structure, covering, ironware, textiles and the finishing, as from the date of purchase and during a period of 2 years.

### SHIPPING

Contact us to find the best shipping method for you.

### BOXE SIZE:

Box with: Width 0.25m,  
Depth 0.25m, Height 1.40m



# CHAIR IM.CA42

DESIGN: DANILO OLIM 2022

## CHAIR IM.CA 42 RELAX[ING]

Design: Danilo Olim by  
DAAO 2022

**IM\_CA42** explores the  
possibilities of a dynamic  
and fun sitting.

**IM\_CA42** is available in  
Birch Plywood



**Chair IM.CA 42**  
new chair IM.CA 42. Create  
a new cone chair concept.  
**Removable backrest**  
Available in Black leather,  
Brown Leather and Fabrics  
(Available in various  
colours)  
DAAO - design[ed] for you





**CHAIR IM.CA 42**  
**RELAX[ING]**  
Design: Danilo Olim by  
DAAO 2022

WOOD AVAILABLE COLORS



PLYWOOD BIRCH

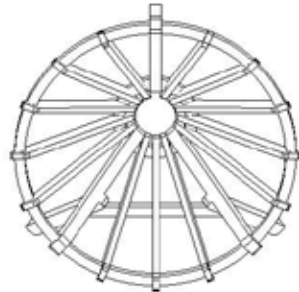

600

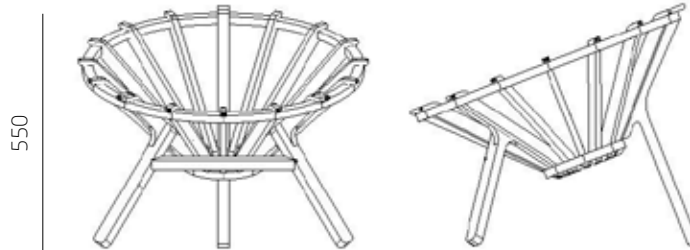

550

600



**SHIPPING**

Contact us to find the best shipping method for you.

**BOX MODULE SIZE:**

Width 0.7m, Depth 0.3m,  
Height 0.45m

**MATERIALS.** Come with us and have a look at our materials.

**FABRICS.** The fabrics shown here, are but only a selection of colours from the collection. We are always searching for high-quality furniture fabrics from renowned manufacturers.

**LEATHER.** Our collection offers different types of leather, with different thickness, colour and pattern.

**FINISHING.** You can choose from wood or lacquer. Check Available woods and colours.

**DAAO guarantee**

The guarantee of our furniture covers material and manufacturing imperfections, namely the structure, covering, ironware, textiles and the finishing, as from the date of purchase and during a period of 2 years.

LEATHER AVAILABLE COLOURS



FABRICS AVAILABLE COLOURS



Our collection offers different types of **leather** and **fabrics**. Come with us and have a look at our materials.



HOMWARE

d+ HOMWARE  
is a brand by

**daao**

# ACCESSORIES

d+ is a brand of accessories by DAAO.

d+ - design[ed] for you

*Wine system  
support 35*  
**INSPIRE YOURSELF**  
Design: Danilo Olim by  
DAAO 2021



This system can be inserted in any furniture base by simply inserting an 8mm hole and then inserting the connection point to the system supplied in the package and the holder itself.



*Wine system  
shelve 35.1*  
**INSPIRE YOURSELF**  
Design: Danilo Olim by  
DAAO 2021





We inverted the way to store the wine glass by holding it from the inside and using the part from the shelf that is not usually used, the bottom of the shelf. We decided to play with the possibilities by

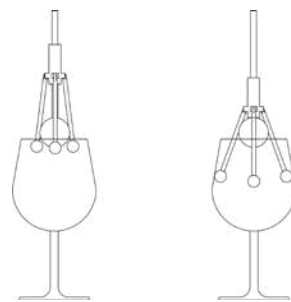

changing their places and creating a prominent place, suspended, for the wine glass. *System 35 is a suspended support for wine glasses.*

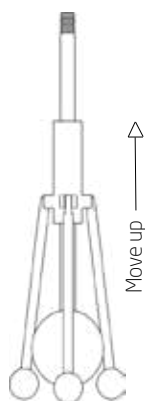
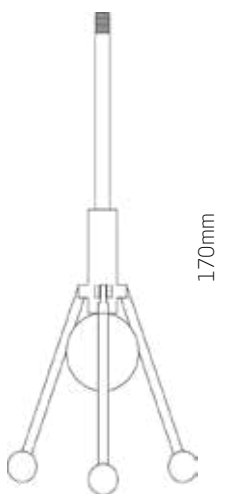

For cup placement, pull the moving piece up and place the cup. Lower the moving piece and it automatically locks the cup.

## 18\_02 HANGER INSPIRE YOURSELF

Design: Danilo Olim by  
DAAO 2022

The concept of the  
18\_02 hangers was  
developed around the  
three purest shapes of  
the design, the circle, the  
triangle and the square.  
In this project we try to  
add to the purity of the  
forms the inexistence of  
hardware.

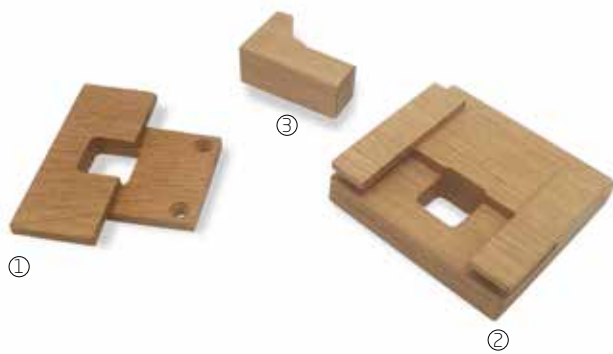

CABIDE 18\_02.3 HANGER  
100x100mm  
OAK

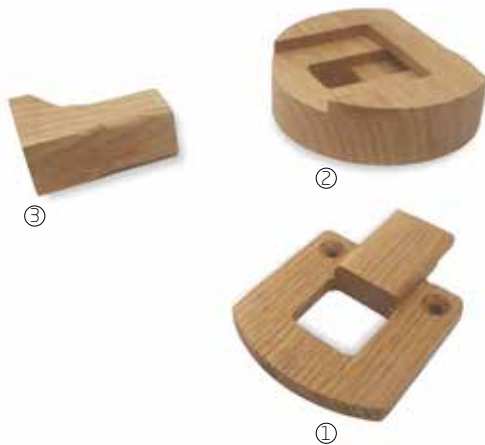

CABIDE 18\_02.1 HANGER  
RADIUS WITH 50mm  
OAK

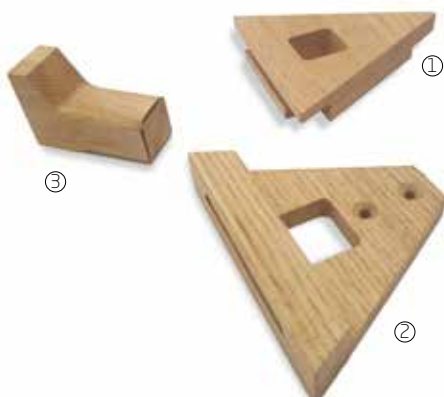

CABIDE 18\_02.2 HANGER  
100x100mm  
OAK



18\_02.1 HANGER

18\_02.2 HANGER

18\_02.3 HANGER

STEP 3 - Insert part 3 into piece 2

STEP 2 - Insert part 2 into piece 1

STEP 1 - Make a hole and screw piece 1 to the wall

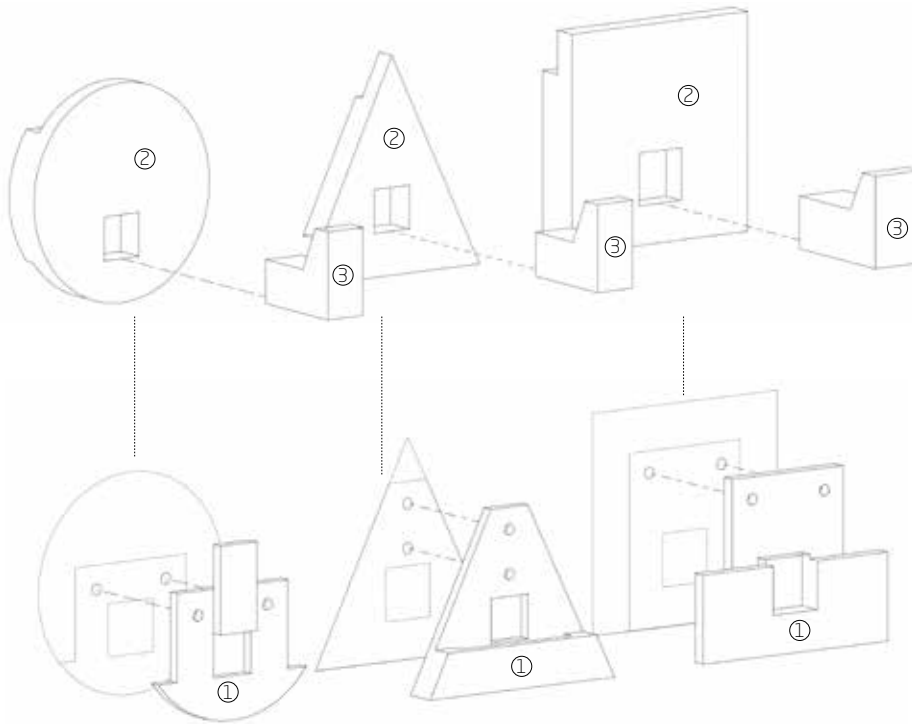

Finishing:  
Birch plywood  
Oak

### 03 Extensible base INSPIRE YOURSELF

Design: Danilo Olim by  
DAAO 2021

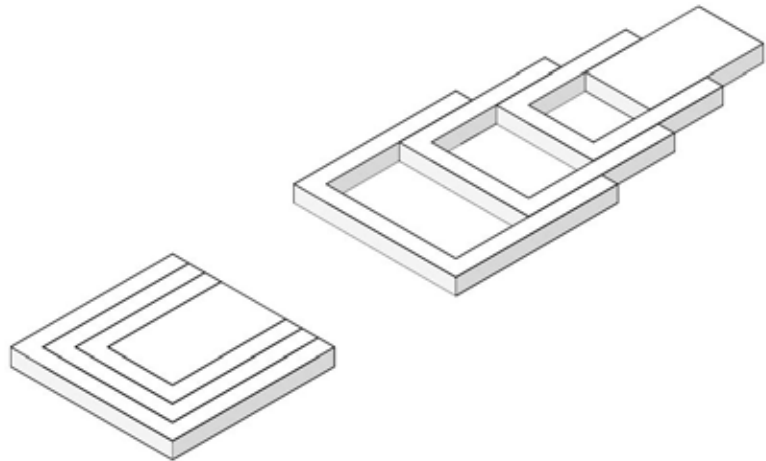

#### 03 It's an extensible base for hot products.

Larger or smaller, you  
adjust depending on your  
needs.

Measures:

Closed: 20x20cm

Opened: 20x34cm

Finishing:

Birch plywood





NEW PRODUCTS  
2022

## NEW PRODUCTS

### SOFA 54

#### RELAX[ING]

Design: Danilo Olim by  
DAAO 2022



Sofa with footrest inserted in tops and easily storable when required. It is an ergonomic and quite comfortable sofa. This sofa can be finished in fabric or leather.



### SOFA 28

#### [RE]IMAGINE YOUR HOME

RE Design: Danilo Olim by  
DAAO 2022

The innovation in our furniture is the most valuable feature of this pieces is its locking systems that allows to construct a different furniture with simplicity makes for an extremely easy assembly process



## TERMS AND CONDITIONS OF USE:

DAAO Concepts – Architecture and Design assures that the information in our website is correct and liable at the time of its insertion, however, you must be aware that DAAO Architecture and Design does not assume any kind of responsibility for typing mistakes in the referred Website, being the responsibility of the customer to request detailed information through our communication channels.

By accessing our Website, you do not acquire any type of rights besides those that contemplate its use and viewing.

You can only use the images and the information of this Website for personal use, never for commercial purposes.

DAAO reserves the right to change, edit or modify its Website at any time and without prior advice.

All information exchange with the customers is confidential and it will never be published.

The Terms and Conditions of this website, as well as all its contents, are in accordance with the Portuguese Law, which the competent authorities have the exclusive jurisdiction.

Questions or doubts related to this Website and to DAAO Concepts Architecture and Design should be emailed to [info@daao.pt](mailto:info@daao.pt)

## HOW TO USE THE WEBSITE TO PURCHASE ONLINE

The online website works at [www.daao.pt](http://www.daao.pt)

Only persons with more than 18 years old can make orders.

The orders are to be validated after payment of 100%.

For orders sent by delivering service, DAAO reserves the right to send the order only after the total delivery amount of the furniture package in question is paid.

After that date, it counts the time established between DAAO and the customer. The counting of the time for the delivering of the order is established with the customer, case by case, according to the previous contacts between DAAO and the Customer.

The purchases as well as any information regarding the furniture can be sent on a 24h basis.

All furniture purchased in our Website belongs to DAAO Collection, being attributed a number to each piece, which is also given to the customer.

The images of the Collection products presented at this Website can have small differences namely the color and configuration, as it is an image/photo.

To Cancel the Orders

The orders can be cancelled up to three days as from the confirmation of same, being the payment done returned to the customer. The order is considered cancelled only after a written confirmation is sent by DAAO.

Pricelist

The price of DAAO furniture is sent by email, on request, being added the VAT, according to the tax in force.

The price does not include any other services, namely the delivery and assembling (if necessary).

The sale price does not apply for orders for resale to the public. These will be negotiated on a case by case basis.

## DAAO FURNITURE GUARANTEE

What does the guarantee cover?

The guarantee of our furniture covers material and manufacturing imperfections, namely the structure, covering, ironware, textiles and the finishing, as from the date of purchase during a period of 2 years. The original invoice/receipt is essential as proof of acquisition. This guarantee is only applied to domestic use.

Please read the following Terms and Conditions before using this Website

## TERMS AND CONDITIONS OF THE WEBSITE:

DAAO Furniture Design website is the responsibility of DAAO Atelier – Architecture and Design.

Please read the Terms and Conditions carefully. All items presented in our website are authored by DAAO – Architecture and Design, and can only be fully or partially reproduced before authorization.

By accessing our website, we assume that you have accepted the conditions imposed by these same Terms of access and use. If you, somehow, do not agree with them, you should not access or even view its content.

CHECK OUR PRODUCTS IN

**daao**

[WWW.DAAO.PT](http://WWW.DAAO.PT)



[@DAAOCONCEPTS](https://www.instagram.com/DAAOCONCEPTS)